

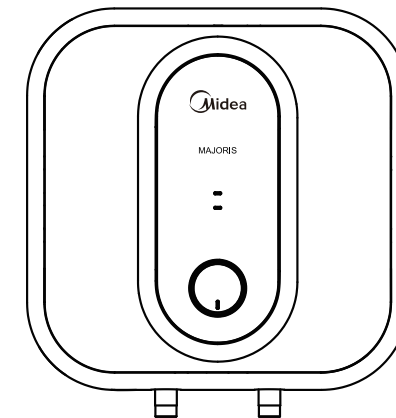

Midea India Private Limited
1 st Floor, Pearl Tower, Plot No.51, Institutional Area,
Sector-32, Gurugram, Haryana-122001, India
Phone No.:01246144300
CIN No.U31906HR2017PTC067945
Customer care No.:18004193333



WATER HEATER OWNER'S MANUAL



Please Read This Manual
Inside you will find many
helpful hints on how to use and
maintain your Water Heater
properly. Just a little preventive care
on your part can save you a great
deal of time and money over the
life of your Water Heater.

Model: MAJORIS SERIES D15-20VG1
MAJORIS SERIES D25-20VG1



Table of Contents

Check on receiving.....	3
Key Features.....	4
Other Features.....	5
Know your product.....	6-7
Instruction before usage.....	8-9-10
safety Precautions.....	11
Internal Wire Diagram.....	12
Installation.....	13-14
How to use.....	15
Specifications.....	16
Maintenance.....	17-18
Troubleshooting.....	19
E-Waste Management Guidelines.....	20
Product Warranty Terms & Conditions.....	21-24
Warranty Card.....	25

Check on Receiving

On receiving your Midea Water Heater

Midea adopts a stringent policy to ensure safe delivery of all its products. All product shipments are thoroughly checked, packed and quality certified before leaving our manufacturing. Please don't accept any product if there is any visible loss or damage of the goods and ask the delivery person to make the note on the freight bill or receipt.

On Opening the box

When a shipment has been delivered to you in apparent good conditions, but upon opening the box, if there is any loss or damage that has taken place due to transit, please inform the Midea Service Centre immediately.

About your instruction/usage manual

This manual is a guide to good usage and operating instructions for your new Midea Water Heater.

This manual does not contain all product service related procedures required for continued successful operation of this product. The services of Midea Authorized Service Person must be employed on periodical basis for the same.

Do not operate the product before reading the manual supplied with this product and follow instructions to ensure personal safety and proper operation.

Midea India Pvt Ltd Limited assumes no liability for installation performed by any unauthorized Person.

Always install, operate, inspect and maintain this product in accordance with all applicable standards.

Please store this user manual carefully for any future reference.

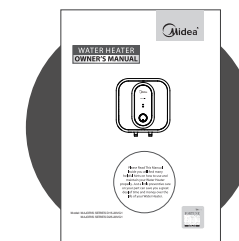

Key Features



Titanium Enamel Glassline Tank
Protection against tank rusting
10 years warranty



Earthing Protection
More safety

IPX4

Waterproof
Grade:IPX4



10-4-2 Warranty*
Midea Water Heater comes with 10 Years Warranty
on Tank , 4 Years Warranty on Heating Element , 2
Years Warranty on Product

**400% |
Mg**

Magnesium Anode
4 Times long life

Other Features



Overall Polyurethane Foam
Better heat retention



Max Working Pressure 0.8MPa
Suitable for high rise buildings



Plastic Body
High impact resistant

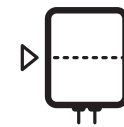

Single Weld Line
Reduce the risk of water
leakage

Know your product

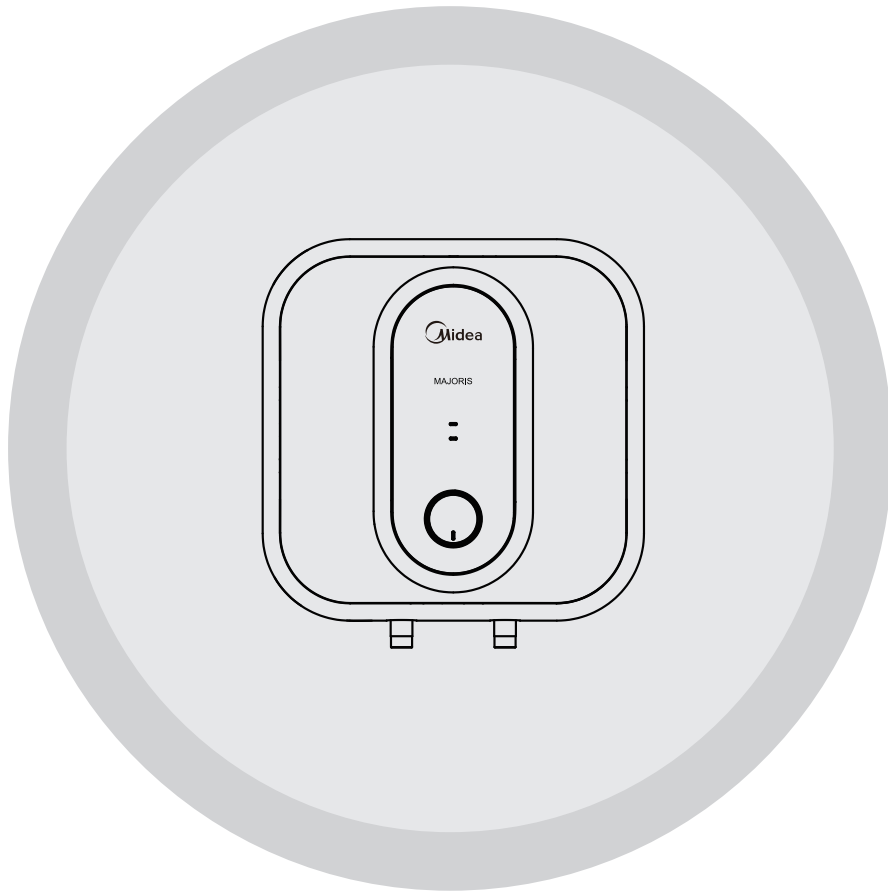

Know your product

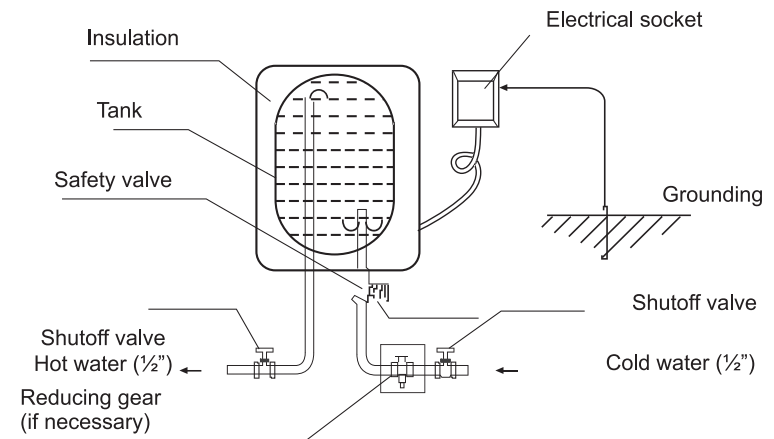

1	Cold water inlet pipe with diuser	To be purchased separately and put at the time of installation
2	Hot water outlet pipe	
3	Safety Valve	Comes with all models
4	Temperature Control Knob	Comes with all models
5	Thermostat	Comes with all models
6	Blue Cap	Comes with all models
7	Red Cap	Comes with all models
8	Anode	Comes with all models
9	Heating Element	Comes with all models
10	Thermal Cut-out	Comes with all models
11	Installation Bracket	Comes with all models

Note: Image may vary from the actual product.

Instructions before use

 CAUTION

Before installing this water heater, check and confirm that the earthing on the supply socket is reliably grounded. Otherwise, the electrical water heater can not be installed and used.



Earthing

Do not use extension boards. Incorrect installation and use of this electrical water heater may result in serious injuries and loss of property.



Prohibited



The supply socket must be earthed reliably. The rated current of the socket shall not be lower than 16A. The socket and plug shall be kept dry to prevent electrical leakage.

16A

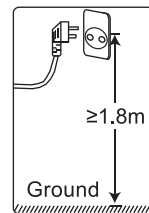
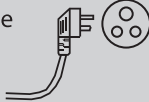

The installation height of the supply socket shall not be lower than 1.8m.

The wall in which the electrical water heater is installed shall be able to bear the load more than two times of the heater filled fully with water without distortion and cracks. Otherwise, other strengthening measures shall be adopted.

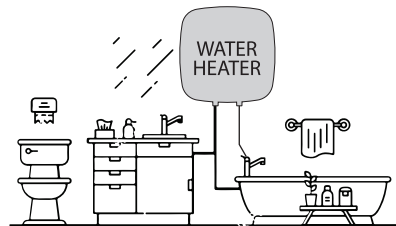

Instructions before use

The pressure release valve attached with the heater must be installed at the cold water inlet of this heater (see Fig. 1), and make sure it is not exposed in the foggy environment. The water may be outflowed from pressure release valve need to the outflow pipe must open wide in the air; The pressure release valve need to be checked and cleaned regularly, so as to make sure it will not

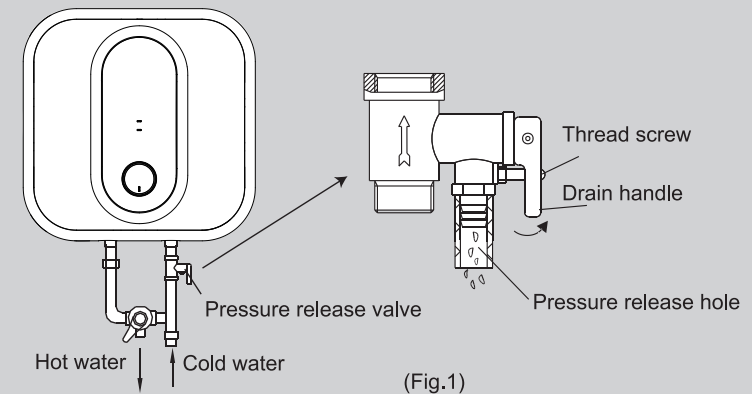

(Fig.1)

When using the heater for the first time (or the first use after maintenance), the heater can not be switched on until it has been filled fully with water. When filling the water, at least one of the outlet valves at the outlet of the heater must be opened to exhaust the air. This valve can be closed after the heater has been filled fully with water.

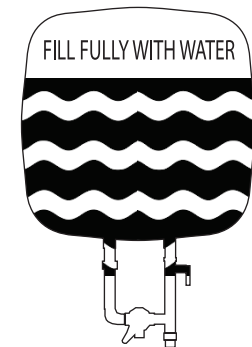

Instructions before use

Note: The water heater is not intended for use by persons (including children) with reduced physical, sensory or mental capabilities, or lack of experience and knowledge, unless they have been given supervision or instructions concerning use of the appliance by a person responsible for their safety. Children should be supervised to ensure that they do not play with the heater.

During heating, there may be drops of water dripping from the pressure release hole of the pressure release valve. This is a normal phenomenon. If there is a large amount of water leak, please contact customer care center for repair. This pressure release hole shall, under no circumstances, be blocked; otherwise, the heater may be damaged, even resulting in accidents.

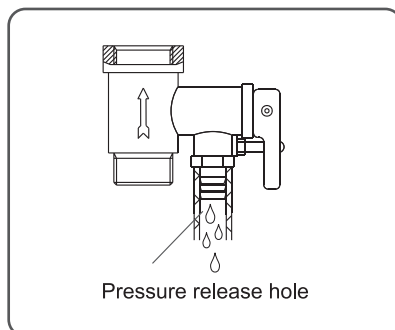

The drainage pipe connected to the pressure release hole must be kept sloping downwards.



Since the water temperature inside the heater can reach up to 75°C, the hot water must not be exposed to human bodies when it is initially used. Adjust the water temperature to a suitable temperature to avoid scalding.

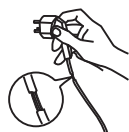
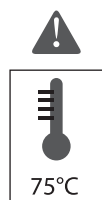

Note: If any parts and components of this electrical water heater are damaged please contact customer care center for repair.

Safety Precautions

During Installation

Do not install the water heater where there is direct sunlight or rain. It has to be installed indoor only.

Do not install the water heater where water splashes on the water heater.

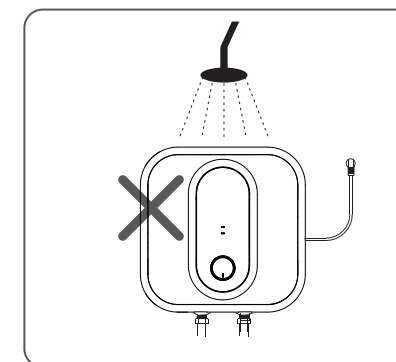
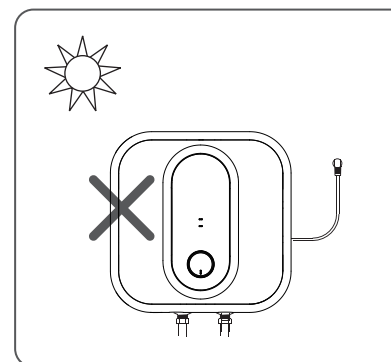

Installing Electrical Connections

Ensure the earth connection in your electrical supply is proper before connecting the power cord. The socket should be standard and independent: 3 pin type of 230V AC, 50Hz.



Connect the power plug to the wall outlet.



- Do not use extension box since it may not be properly earthed.
- The appliances must be earthed. Midea India doesn't hold any responsibility for damage caused by failure to observe above rule. You are therefore advised to check that your household supply has efficient earthing.
- Do not use manual stabilizer.

Internal Wire Diagram

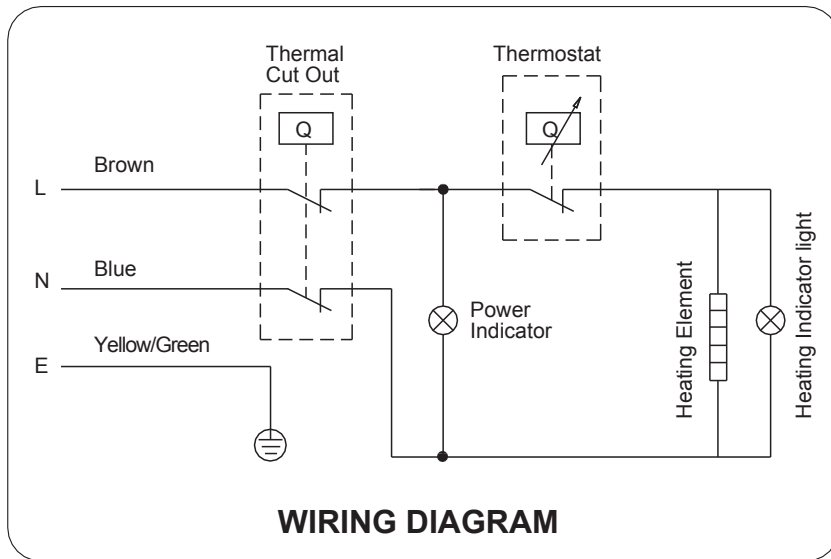

Installation

Installation Instruction

- This electrical water heater shall be installed on a solid wall. If the strength of the wall cannot bear the load equal to two times of the total weight of the heater filled fully with water, it is then necessary to install a special support. In case of hollow bricks wall, ensure to fill it with cement concrete completely.
- After selecting a proper location, determine the positions of the two install holes used for expansion bolts with hook (200mm). Make two holes in the wall with the corresponding depth by using a chopping bit with the size matching the expansion bolts attached with the machine, insert the screws, make the hook upwards, tighten the nuts to fix firmly, and then hang the electrical water heater on it (see Fig.2).

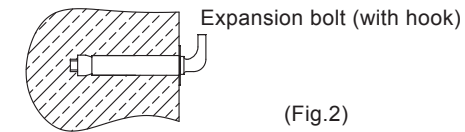

- Install the supply socket in the wall. The supply socket should be 250V/10A. It is recommended to place the socket on the right above the heater. The height of the socket to the ground shall not be less than 1.8m (see Fig.4). If there is fault on power cable, it should be replaced by the manufacturer, agencies or qualified person who is able to do this so as to ensure the safety.

- If the bathroom is too small, the heater can be installed at another place. However, in order to reduce the pipeline heat losses, the installation position should not be too far from faucets. Please note that it should not be closed to Kitchen.

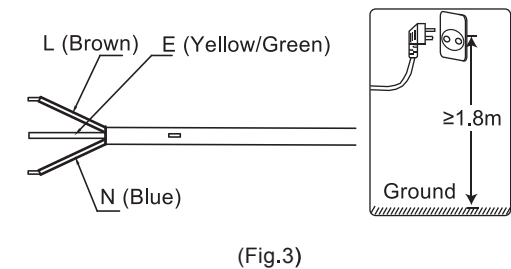

Installation

Pipelines Connection

- It is Strongly recommended to use flexible pipes at inlet and outlet points The maximum pressure that pipe is able to withstand is 16 bar
- Connection of pressure release valve with the heater on the inlet of the water heater.
- In order to avoid leakage when connecting the pipelines, the rubber seal gaskets provided with the heater must be added at the end of the threads to ensure leak proof joints (see Fig.5).

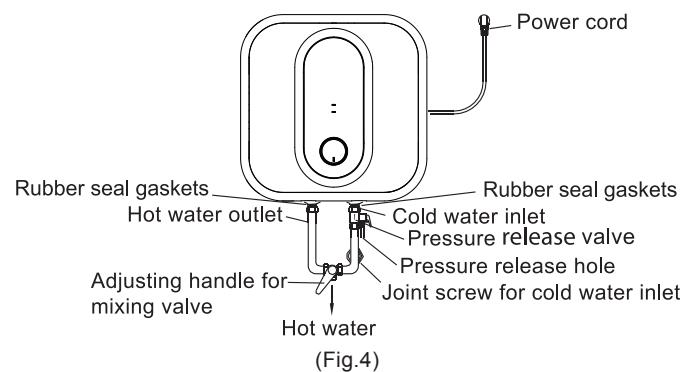

Note: Please be sure to use the accessories provided with product to install this electric water heater. This electric water heater can not be hung on the support until it has been confirmed to be firm and reliable. Otherwise, the electric water heater may drop off from the wall, resulting in damage of the heater, even serious accidents of injury. When determining the locations of the bolt holes, it shall be ensured that there is a clearance not less than 0.2m on the right side of the electric heater, to convenient the maintenance of the heater, if necessary.

How to use

During normal operation, the inlet valve shall be always kept open.

- Insert the supply plug into the socket.
- If the indicator lights up, the thermostat will automatically control the temperature. When the water temperature inside the heater has reached the set temperature, it will switch off automatically, when the water temperature falls below the set point the heater will be turned on automatically to restore the heating.

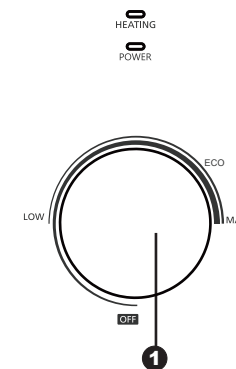

(Fig 5)

- ① Rotate the knob according to the marking on the knob to increase or decrease the setting temperature.
- ② In a power-on state, the machine is heating when the Power indicator light is white. The Heating indicator light goes out when the heating process is finished, in the insulating state.

Specifications

Model No	MAJORIS SERIES D15-20VG1	MAJORIS SERIES D25-20VG1
Voltage/Freq.	230V/50Hz	
Rated Power	2000W	
Capacity	15L	25L
Star Rating	4Star	
Max Working Pressure	0.8MPa	
Half Tank/Full Tank heating	No	No
Digital Display	No	No
Temperature Range	30°C to 75°C	

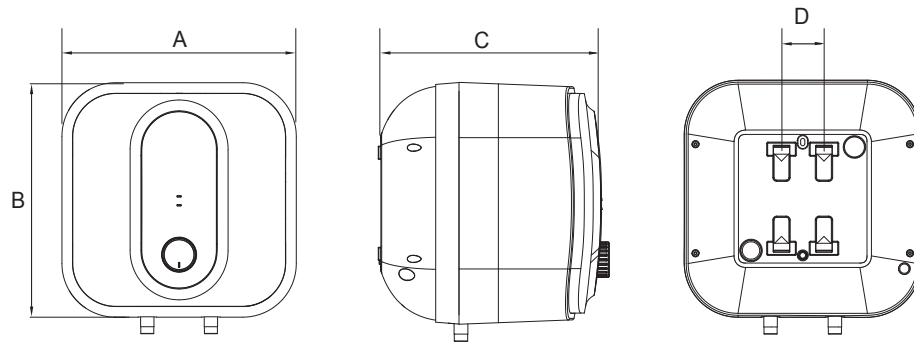

Capacity	15L	25L
Model No.	MAJORIS SERIES D15-20VG1	MAJORIS SERIES D25-20VG1
A	368	440
B	368	440
C	340	420
D	66	66

(Note: All dimensions are in mm)

Maintenance

WARNING!

Do cut off power supply before maintenance, to avoid danger like electric shock.

- Check the power plug and outlet as often as possible. Secure electrical contact and also proper grounding must be provided. The plug and outlet must not heat excessively.
- If the heater is not used for a long time, especially in regions with low air temperature (below 0°C), it is necessary to drain water from the heater to prevent damage of the water heater, due to water freezing in the internal tank. (Refer Cautions in this manual for the method to drain away the water from the inner container).
- To ensure long reliable water heater operation, it is recommended to regularly clean the internal tank and remove deposits on the electric heating element of the water heater, as well as check condition (fully decomposed or not) of the magnesium anode and, if necessary, replace it with a new one in case of full decomposition. Tank cleaning frequency depends on hardness of water located in this territory. Cleaning must be performed by special maintenance services. You can ask the seller for address of the nearest service center.
- The water heater is equipped with a thermal switch, which cuts off power supply of the heating element upon water overheating or its absence in the water heater. If the water heater is connected to the mains, but water is not heated and the indicator doesn't light up, then the thermal switch was switched off or not switched on. To reset the water heater to the operating condition, it is necessary to:
 1. De-energize the water heater, remove the plate of the side/lower cover.
 2. Press the button, located at the center of the thermal switch, see Fig.8;
 3. If the button is not pressed and there is no clicking, then you should wait until the thermal switch cools down to the initial temperature.

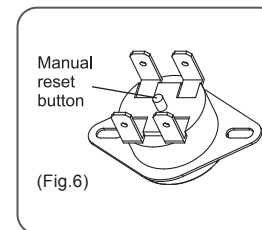

WARNING!

Non-professionals are not allowed to disassemble the thermal switch to reset. Please contact professionals to maintain. Otherwise our company will not take responsibility if any quality accident happens because of this.

Maintenance



Do cut off power supply before maintenance, to avoid danger like electric shock.

- Check the power plug and outlet as often as possible. Secure electrical contact and also proper grounding must be provided. The plug and outlet must not heat excessively.
- If the heater is not used for a long time, especially in regions with low air temperature (below 0°C), it is necessary to drain water from the heater to prevent damage of the water heater, due to water freezing in the internal tank. (Refer Cautions in this manual for the method to drain away the water from the inner container).
- To ensure long reliable water heater operation, it is recommended to regularly clean the internal tank and remove deposits on the electric heating element of the water heater, as well as check condition (fully decomposed or not) of the magnesium anode and, if necessary, replace it with a new one in case of full decomposition. Tank cleaning frequency depends on hardness of water located in this territory. Cleaning must be performed by special maintenance services. You can ask the seller for address of the nearest service center.
- The water heater is equipped with a thermal switch, which cuts off power supply of the heating element upon water overheating or its absence in the water heater. If the water heater is connected to the mains, but water is not heated and the indicator doesn't light up, then the thermal switch was switched off or not switched on. To reset the water heater to the operating condition, it is necessary to:
 1. De-energize the water heater, remove the plate of the side/lower cover.
 2. Press the button, located at the center of the thermal switch, see Fig.8;
 3. If the button is not pressed and there is no clicking, then you should wait until the thermal switch cools down to the initial temperature.

Manual reset button

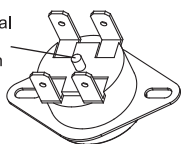

(Fig.6)



Non-professionals are not allowed to disassemble the thermal switch to reset. Please contact professionals to maintain. Otherwise our company will not take responsibility if any quality accident happens because of this.

Troubleshooting

Failures	Reasons	Treatment
The heating indicator light is off.	Failures of the temperature controller.	Contact with the professional personnel for repair.
No water coming out of the hot water outlet.	1. The running water supply is cut off.	1. Wait for restoration of running water supply.
	2. The hydraulic pressure is too low.	2. Use the heater again when the hydraulic pressure is increased.
	3. The inlet valve of running water is not open.	3. Open the inlet valve of running water.
The water temperature is too high.	Failures of the temperature control system.	Contact with the professional personnel for repair.
Water leak.	Seal problem of the joint of each pipe.	Seal up the joints. Should be done by CMI authorized service technician

Note: Parts illustrated in this use and care manual are indicative only, parts provided with the product may differ with illustrations. This product is intended for household use only. Specifications are subject to change without notice.

E-Waste Management Guidelines

PROPER HANDLING AND/OR RECYCLING OF THE WATER HEATER

Under the E-Waste (Management) Rules, 2011 (hereafter referred to as the "E-Waste Rules"), it is incumbent for all consumers, including the purchaser of this water heater, to properly recycle and dispose of all electrical and electronic equipment through authorized recyclers. E-Waste has been defined as "waste electrical and electronic equipment, whole or in part or rejects from their manufacturing and repair process, which are intended to be discarded". E-Waste contains various hazardous materials like lead, mercury, cadmium, hexavalent chromium, polybrominated biphenyls and polybrominated diphenyls ethers. Hence, improper handling and disposal of e-waste releases these hazardous material in the environment causing pollution, contamination of soil and water and various health hazards. Though the product purchased by you does not contain any hazardous material above the prescribed limit under the E-Waste Rules, it is imperative that the product should be handled with utmost caution and as per the guidelines mentioned in this manual including the following Do's and Don'ts –

Do's	Don't's
Hand over the E-Waste to the Company / Authorised recycler	Never sell the e-waste to any unauthorized agencies, scrap dealer/kabadiwalahs.
E-Waste should never be thrown in household bins.	Never throw E-Waste in bins as part of household waste.
Keep the product in isolated area, after it becomes non-functional/un-repairable so as to prevent its accidental breakage.	Never keep E-Waste in open and exposed area, accessible by all.
The product should not be opened by the User himself/ herself, but only by authorised service personnel.	Never open/dismantle any e-waste on your own.

The following marking/symbol on the product or carton indicates that the product and its accessories/parts (e.g. remote controller, batteries, spare parts etc.) should not be disposed of with other household waste at the end of their working life. Please separate these items from other types of waste and recycle them responsibly for conservation of the environment and collective well-being.



E-WASTE RECYCLING PROGRAM

We have tied up with government approved e-waste recycler for facilitating the collection of e-waste from our channel partners and customers for recycling. You are simply required to call our toll free number **1800 4193 333** and register your request for collection of e-waste. Once your request is received, the representatives of the authorized recycler would collect the e-waste from your house/premises after paying the value of the same to you. For more details and information on our E-Waste Recycling Program kindly visit our website : www.carriermideaindia.com.

Product Warranty Terms & Conditions

MIDEA INDIA PRIVATE LIMITED (hereinafter referred to as the "company"), hereby warrants to the original domestic purchaser (here in after called the "Purchaser") of the product (as detailed within the warranty Registration Card and herein after referred to as the "said unit") that the said unit is free from defects in material and workmanship under normal use and service and under specified voltage conditions, and that during a period of twenty four (24) months commencing from date of invoice, as provided in Warranty Registration Card, the company undertakes to repair or to replace as it deems fit in sole discretion, free of charge, any part or parts of the said unit (including accessories) which proves to be defective in material or workmanship.

EXTENDED WARRANTY

The Water Heater needs to be installed by MI suthorised service technician to avail advantage of standard and extended warranty. Extended warranty is applicable for following components for the period mentioned after expiration of standard warranty mentioned above (24 Months).

- Tank : 96 months following the expiration of standard warranty
- Glassline Heating Element : 24 months from the expiration of standard warranty

The company shall continue to warrant the water tank and heating element to be free from defects in material and workmanship under normal use and service and under specified voltage conditions. During the additional warranty period, it does not cover any other part such as overload protector, relay thermostat etc. Standard visting charges will be applicable within the municipal limit of town where company has it's authorised service centre. Service outside municipal limit will attract to and fro travelling, other incidental expenses in addition to standard visiting charges as prevailing from time to time. During the warranty period, only the parts replaced or repaired shall be free of of costs but service charges shall always be payable by the customer. Expandable items like wiring, thermostat etc and others are excluded from this warranty and are on chargeable basis. This warranty is subject to use of product with input voltage pf 230 V +/-10%. We recommend use of approved voltage regulation/protection devices.

CONDITIONS OF WARRANTY

- The warranty shall be valid if and only if the purchaser has duly intimated the fault to the company or its authorized dealer and that the unit is in the possession of and is used by the Purchaser.
- At the time of repair/service, the Purchaser is mandatorily required to show the original invoice to the authorized service personnel of the Company. If the Purchaser fails to do so, then all repair work and service shall be carried out on a chargeable basis;
- The warranty will shall be valid only for the said period as specified above, irrespective of whether the said unit has been in use or not for any reason whatsoever, or the unit is moved from one location to another.
- The warranty period specified above shall include time taken for repairs, replacements, testing of unit, technical breakdowns, transit time etc. This warranty shall automatically expire by efflux of time on completion of the period indicated herein above and no notice of such expiry will be given by the company.
- This warranty shall stand automatically terminated in the event of the said unit being serviced, repaired, installed, de-installed, re-installed or otherwise attended to by any person, organization, agency or by the Purchaser himself (by whatever name called), other than the authorized representative/Dealer of the company.
- Parts of the units replaced or repaired under the terms of this warranty are warranted only for the remaining period of the original warranty period.
- For attending any service call under this warranty beyond the Municipal limit of the locality in which the authorized representative/dealer is situated (outstation locations), all to & fro travelling and other incidental expenses as prevailing from

Product Warranty Terms & Conditions

time to time incurred in connection with visit of service personnel, technicians etc., shall be borne by the purchaser and shall be payable in advance. Additionally, all expenses incurred by authorized representative/dealer in collecting the unit or any part thereof from such outstation locations and its return to the original location shall be borne exclusively by the Purchaser.

8. Any damage/fault caused due to sabotage, improper handling or treatment, carelessness, accident fire, flood, earthquake or any act of god, or any corrosive action on the original fittings, valves etc. for whatever reasons, shall not be covered under this warranty.
9. While the Authorized Dealers/Company will make every effort to carry out repairs/replacement of parts under this warranty as soon as the complaint is received, it is expressly made clear that the Authorized Dealer/Company shall not be liable to do so within any specified period of time.
10. It shall be absolute discretion of the company to (a) effect the repairs or replacement of parts whether at the site of installation or at any service center; and (b) have the job attended to either by the Company's service personnel or its authorized dealers/service centers. (c) This warranty shall be strictly limited to the repairs or replacement of defective parts specified in the warranty. This warranty shall not cover any consequential or resulting liability. (d) The warranty shall not in any case extend towards payments of an monetary consideration whatsoever or replacement or return of the product. (e) The parts shall be replaced by functionally operating equivalent material only and the same may be different from the one originally fitted. The parts replaced during warranty period shall be taken back by the company at its sole discretion.
11. This warranty is in the nature of and for the purpose as set forth herein above and in particular, the Company shall not in any event be liable for any indirect, incidental or consequential loss or damages to the said purchaser and/or his property or any other third party in course of attending to any complaint.
12. In the event of any change in the location of the unit, during the warranty period, this warranty shall become null and void unless the fact of the proposed change is communicated in writing to the authorized dealer at least seven (7) days prior to the said change. On receipt of such information, the authorized dealer or any of its counterparts shall arrange for de-installation of the said unit on a chargeable basis. However, it is expressly stated that in the event of any damage occurring to the unit or to any of its parts during the course of its transit by the Purchaser, repair or replacement of the said unit or any part thereof so damaged shall not be covered by this warranty.
13. While the Authorized Dealers/Company will make every effort to carry out repairs/replacement of parts under this warranty as soon as the complaint is received, it is expressly made clear that the Authorized Dealer/Company shall not be liable to do so within any specified period of time.
14. Exclusions from warranty:
 - i. Noise or vibration that is considered normal for product operations like warning beeps, water drain sound, spin sound etc.;
 - ii. Correcting the installation, for example levelling the product, adjustment of inlet tap/drain hose etc.;

Product Warranty Terms & Conditions

- iii. Normal Maintenance which is recommended by the user's manual;
- iv. Removal of foreign objects/substances from the machine, including the pump and inlet hose filter for example grit, nails buttons etc.;
- v. Replace fuses in or correct house wiring or correct house plumbing;
- vi. On-line filter, inlet/exhaust extension hoses, tap adapter, extended power supply cable, adjustment feet cover etc. thereof;
- vii. This warranty does not cover any type of painting, plating including rusting etc. or defects thereof.
- viii. Plastic & glass parts such as door, Lid assembly, Control Panel, Window, Knobs, Cabinet, Dispenser assembly, Drain Pipe, Lint Filter, Wheels / Foot etc. are also not covered in warranty.
15. Limitation of Warranty : Company shall not be responsible for providing any warranty under the following situations :
 - i. If the product is used for commercial purpose. (example: Public places such as hotels, lodging house, restaurants, dormitory etc.);
 - ii. Any damage caused by any accident, mishandling, tampering with installation, or negligent in following instructions of the user manual issued by the company. If the products has been installed/serviced/repaired/opened or tampered by any unauthorized personnel;
 - iii. Any damage caused by power surges and dips, improper electric circuit outside the unit or by any defective electrical supply.
 - iv. If the defect is caused by insects, rats, birds, squirrels, pests or any other external factors like fire, flood, earthquake, lightning and /or any other act of God/Natural calamities;
 - v. Any defect due to substitution of original components with duplicate, fake or non-genuine components;
 - vi. At any time, during the currency of the warranty period, if any part of the unit is tampered with altered, repaired or serviced by any unauthorized person, not being the authorized representative of the company or its authorized dealers;
 - vii. If defects arises due to optional accessories like trolleys, rat mesh, machine cover etc;
 - viii. The serial no on the unit or any part thereof is damaged, defaced, altered, obliterated, or tampered with or removed for any reason whatsoever;
 - ix. The product is shifted outside India;
 - x. Damage to the product due to operation in an abnormally corrosive alkaline/acidic atmosphere or near muddy sewages because toxic gases are harmful for the product;
16. None of the employees and/or Authorized dealers of the Company have the authority whatsoever to vary the terms and conditions of this warranty.
17. This warranty shall be deemed to have been issued at Gurugram in the State of Haryana, and courts at Gurugram shall have exclusive jurisdiction on matters covered by or following from this warranty and the Purchaser alone shall have cause of action arising out of transaction.

Memo

Large empty rectangular area for writing a memo.

WARRANTY CARD



CUSTOMER COPY

Invoice no. : _____ Date of Purchase : _____

Customer Name : _____

Address : _____

Product Name : _____ Model No. : _____

Sr. No. of the Unit : _____

Dealer's Name & Address : _____

Signature of the Dealer : _____ Dealer's Seal : _____

Midea India Privated Limited



MIDEA COPY

Invoice no. : _____ Date of Purchase : _____

Customer Name : _____

Address : _____

Product Name : _____ Model No. : _____

Sr. No. of the Unit : _____

Dealer's Name & Address : _____

Signature of the Dealer : _____ Dealer's Seal : _____

Midea India Privated Limited